

JURA

BY GRS®



QC COMPLETE SET

INCLUDING MICROBLOCK®

500 - 510 • INSTRUCTIONS

Includes: MicroBlock® w/ Jura Master Jaws, Small Vise Base, Jura Must Have 5 mm Hex Key, Organizers, Horizontal Inside Ring Holder, Vertical Inside Ring Holder, 10 Plastic Collets, Flat Clamps with Groove, Outside Ring Holder, 6 mm Cylinder Top, 10 mm Cylinder Top, 20 mm Round Top, 20 mm Straight Top, 40 mm Straight Top, Engravers Clamps with 2.34 mm Holes, Thermo-Loc® Engravers Clamps, Shellac Plate, Thermo-Loc Cylinder, Shellac Cylinder, Tapered Point Holders, Tapered Ball Holders

MASTER JAWS

INSTRUCTIONS

Instructions apply to the following product(s):



500-018

IMPORTANT NOTE:
The MicroBlock® and MicroBlock® XL Jura by GRS sets include a pair of Master Jaws instead of the original jaws with pin holes.

Skip to **Installation of Master Jaws** unless you need to remove original MicroBlock jaws from a previously purchased vise.

Products that include Master Jaws instead of original MicroBlock jaws:
#500-508, #500-510, #500-517,
#500-526, #500-527

✓ Included with this set.

◆ Not included with this set. Available separately.

Removal of Original MicroBlock® Jaws

Skip to **Installation of Master Jaws** unless you need to remove original MicroBlock jaws from a previously purchased vise.

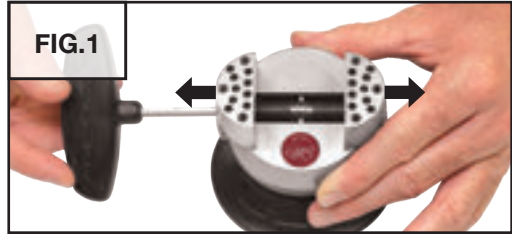

Installation of Master Jaws

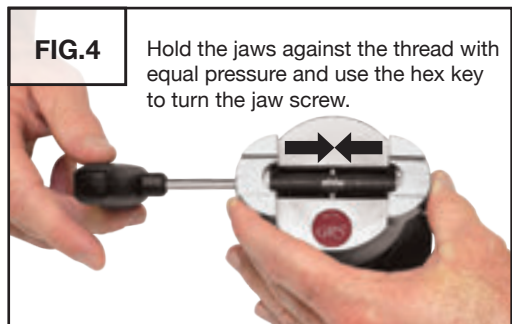

Microblock® shown with Jura Master Jaws #500-018
 (See instructions for installation on pg 2).

MICROBLOCK® W/ MASTER JAWS

INSTRUCTIONS AND PARTS LIST

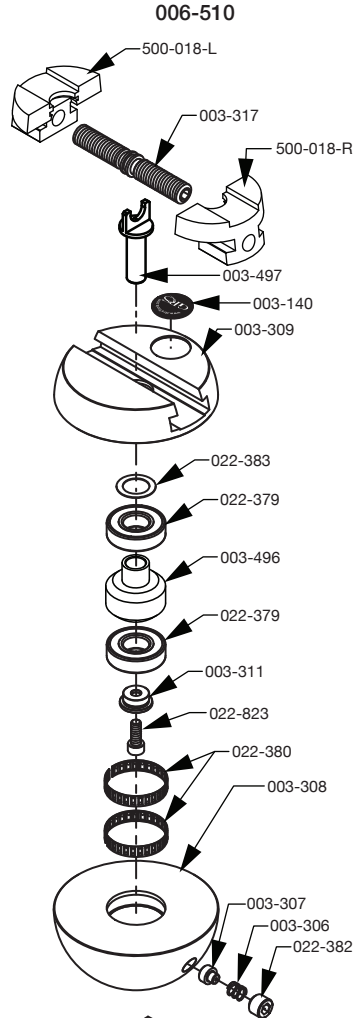
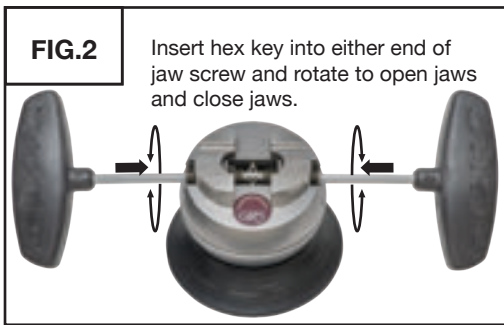
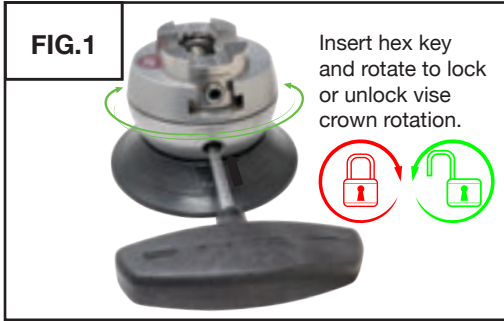

PART #	DESCRIPTION	QTY
002-067	10-32 x 1/2" SHCS	1
003-140	GRS Label	1
003-306	Drag Spring	1
003-307	Lock Pin	1
003-308	Stainless Steel 80 mm Base	1
003-309	Crown	1
003-311	Bearing Retainer	1
003-496	Bearing Spacer Brake Rotor	1
003-497	Jaw Screw Yoke	1
003-317	Jaw Screw	1
003-679	Thermo-Loc Sample Kit	1
022-379	Shielded Bearing	2
022-380	Tolerance Ring	2
022-382	Flat Nose Set Screw	1
022-383	.015" x .513" x .750" SS Washer	1

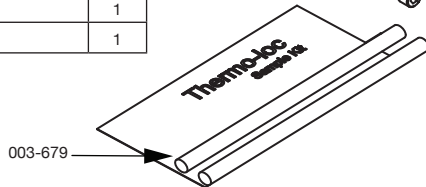

SEATED QC FIXTURES

INSTRUCTIONS

Instructions apply to the following product(s):

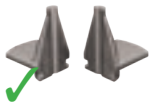

500-001

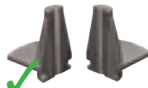

500-002



500-003

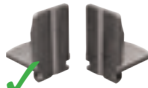

500-004



500-005



500-006



500-007



500-009



500-010



500-013



502-078

Fixture Attachment



BOTTOM



SIDE



ANGLE

Master Jaw Seat



Fixture Installation



✓ Included with this set.

◆ Not included with this set. Available separately.

INSIDE RING HOLDER SCREW SET

INSTRUCTIONS

Instructions apply to the following product(s):



✓
500-011

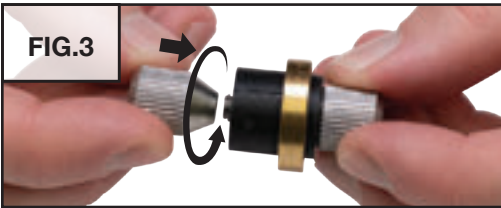
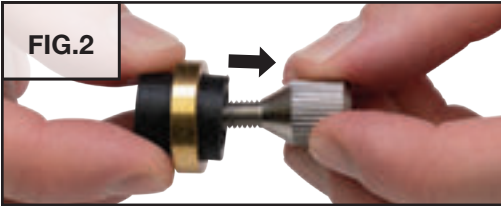
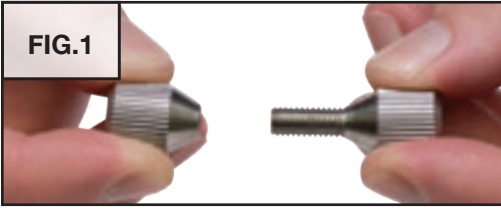

SHELLAC CYLINDER

INSTRUCTIONS

Instructions apply to the following product(s):



✓
502-015



Follow the shellac instructions to apply shellac and workpiece to cylinder.

THERMO-LOC® CYLINDER

INSTRUCTIONS

Instructions apply to the following product(s):



✓
502-502

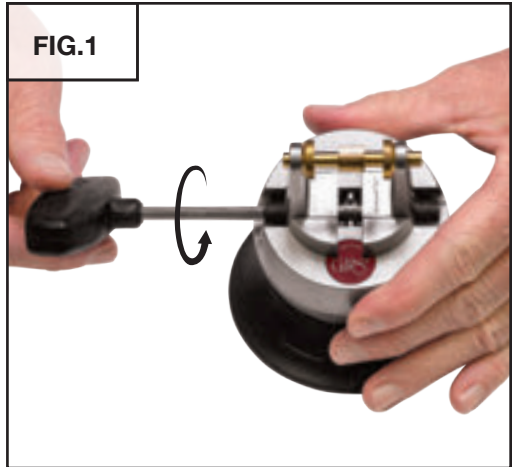

Follow the Thermo-Loc® instructions to apply Thermo-Loc® and workpiece to cylinder.

✓ Included with this set.

◆ Not included with this set. Available separately.

Fixture Installation

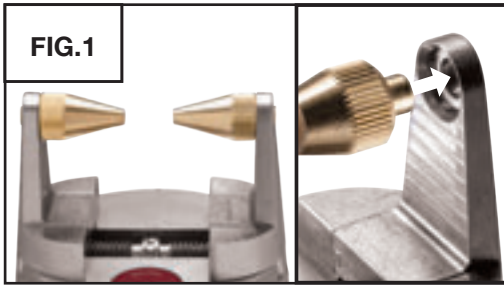

Fixture Usage

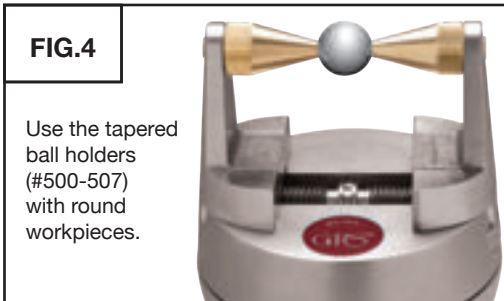
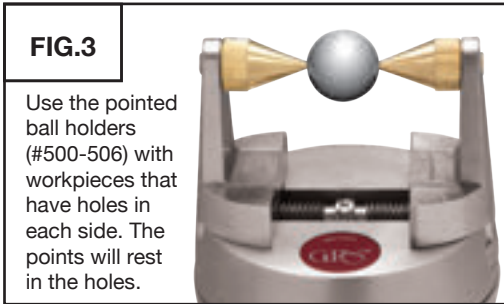
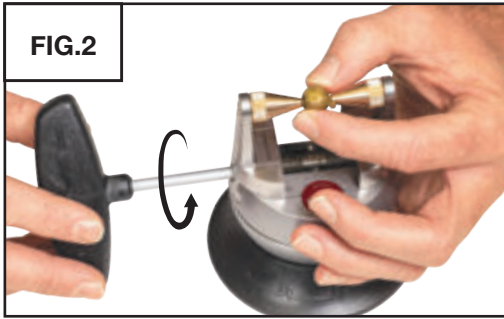

POINTED AND TAPERED BALL HOLDERS

INSTRUCTIONS

Instructions apply to the following products:



ROUND-BASE QC FIXTURES

INSTRUCTIONS

Instructions apply to the following product(s):



500-501



502-501

Fixture Attachment



BOTTOM



SIDE



ANGLE

Fixture Installation

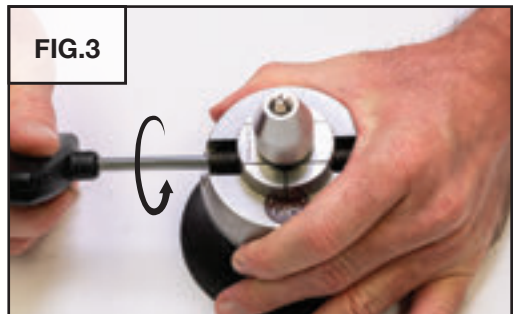
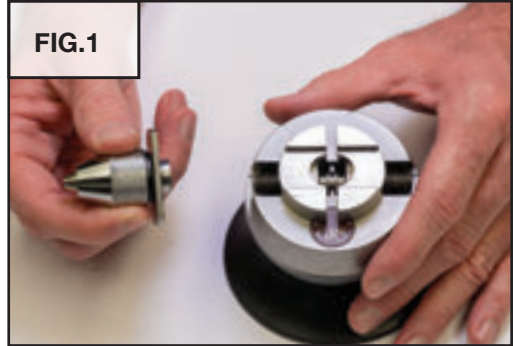

✓ Included with this set.

◆ Not included with this set. Available separately.

VERTICAL RING HOLDER

INSTRUCTIONS

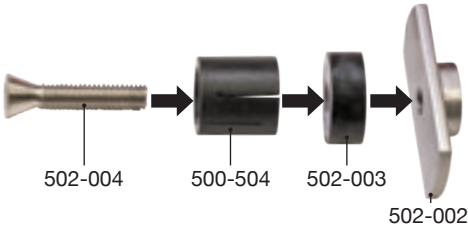

Instructions apply to the following product(s):

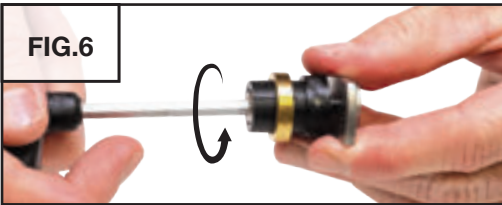

QC SHELLAC PLATE

INSTRUCTIONS

Instructions apply to the following product(s):



500-014

Fixture Attachment

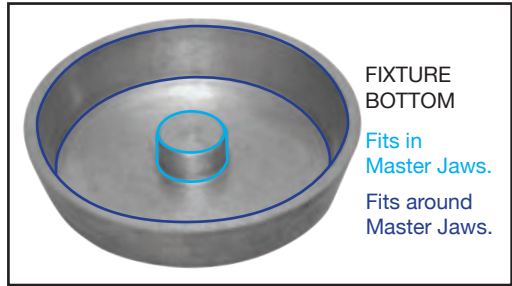

Fixture Installation



✓ Included with this set.
◆ Not included with this set. Available separately.

Follow the shellac instructions to apply shellac and workpiece to plate.



FIG. 1

Clean organizer back and bench surface with isopropyl alcohol according to manufacturer's instructions.



FIG. 2



FIG. 3



FIG. 4



FIG. 5



FIG. 6

Place organizer where desired and press firmly for 60 seconds.

ORGANIZERS WITH TAPE ATTACHMENT

INSTRUCTIONS

Instructions apply to the following product(s):



500-523



500-524



502-034



502-045



523-011



523-012



523-013



523-029



523-030

